

PER:
FOR:

ASSA (S)

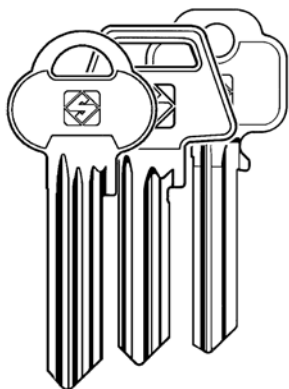

6-7 PIN KEYS

(DP, CLIQ)
(D-12)

可选
OPTIONAL

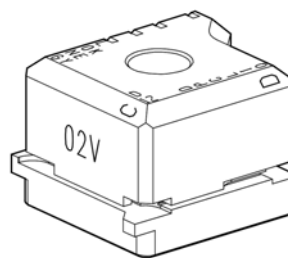

D743271ZB

02V 夹钳 (ASSA 型钥匙, 即: 长型钥匙, D-12*, DP, CLIQ)
02V clamp for ASSA type keys (long keys, D-12*, DP, CLIQ)

*D-12: 代码保护类可复制钥匙
*D-12: Key duplicable by code only

PER:
FOR:

CISA (I)

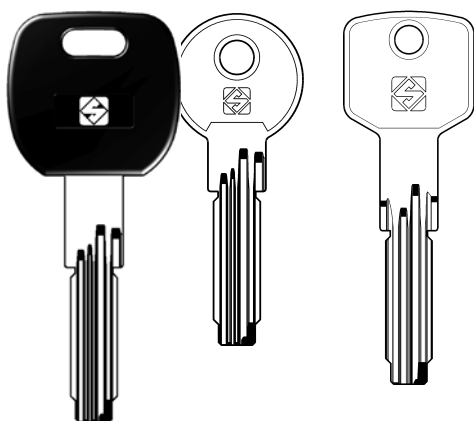

CS70P

CS70

CS62
ASTRAL
system 357

AB48
ABUS

可选
OPTIONAL



D743261ZB
05J 夹钳
05J Jaw

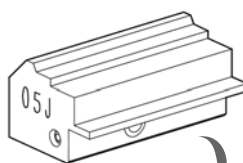

可选
OPTIONAL



D743262ZB
06J 夹钳
06J Jaw

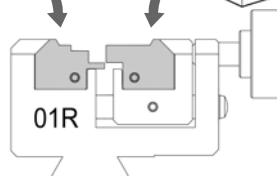
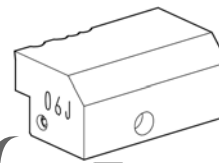

标准
STANDARD



D742867ZB
01D 刀具
Cutter 01D

ASTRAL system:

Silca 公司根据建造者授权而提供的有密码保护的代码表。

Codes tables protected by a password issued by Silca on receipt of the manufacturer's authorization.

PER:
FOR:

DOM (D) CORBIN (I)

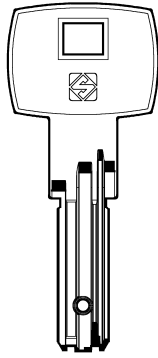

DM144
IX6 KG Profile 121

可选
OPTIONAL



D743269ZB
09J 夹钳
09J Jaw

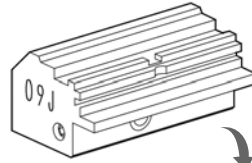

可选
OPTIONAL



D743270ZB
10J 夹钳
10J Jaw

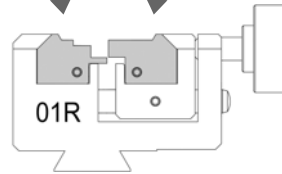
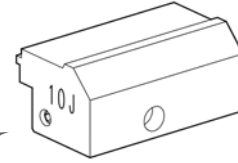

标准
STANDARD



D742867ZB
01D 刀具
Cutter 01D

PER:
FOR:

HUWIL (D)

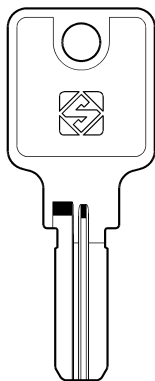

HW15R

可选
OPTIONAL



D743362ZB
16J 夹钳
16J Jaw

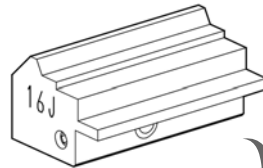

可选
OPTIONAL



D743365ZB
17J 夹钳
17J Jaw

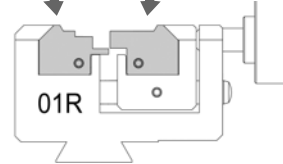
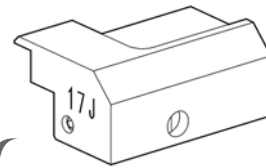

标准
STANDARD



D742606ZB
01L 刀具
Cutter 01L

PER:
FOR:

ISEO (I)

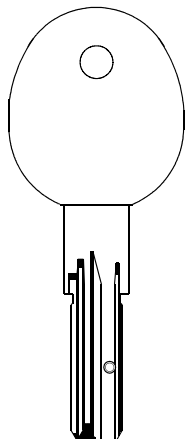

ISR100 WEB / R100 / R50

可选
OPTIONAL
CODE
COPY

D743278ZB
11J 夹钳
11J Jaw

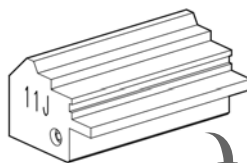

标准
STANDARD
CODE
COPY

D943254ZR
02J 夹钳
02J Jaw

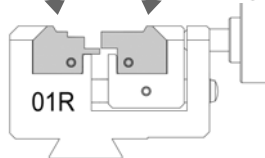
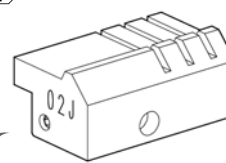

标准
STANDARD



D742867ZB
01D 刀具
Cutter 01D

Silca 公司根据建造者授权而提供的有密码保护的代码表。

Codes tables protected by a password issued by Silca on receipt of the manufacturer's authorization.

PER:
FOR:

KABA (CH)

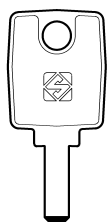

KA8
(KABA-MICRO)

可选
OPTIONAL
CODE
COPY

D729845ZB
A18 适配器
A18 adapter

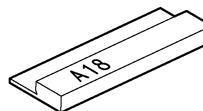

标准
STANDARD
CODE
COPY

D943253ZR
01J 夹钳
01J Jaw

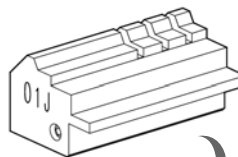

标准
STANDARD
CODE
COPY

D943254ZR
02J 夹钳
02J Jaw

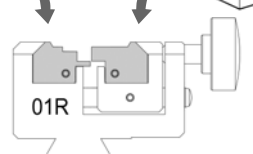
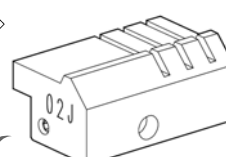

标准
STANDARD



D742867ZB
01D 刀具
Cutter 01D

PER:
FOR:

KABA (CH)



(KABA Exper T)

可选
OPTIONAL



D746713ZB
05R 夹钳
05R Clamp

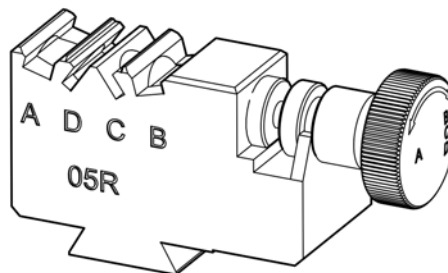

可选
OPTIONAL



D746736ZB
10D 刀具
Cutter 10D

Silca 公司根据授权提供密码保护的系统
System protected by a password issued by Silca on receipt of authorization.

PER:
FOR:

KYR (I)

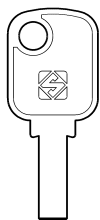

SCU1
SECURITAL

可选
OPTIONAL



D729845ZB
A18 适配器
A18 adapter

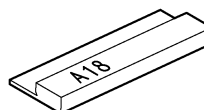

标准
STANDARD



D943253ZR
01J 夹钳
01J jaw

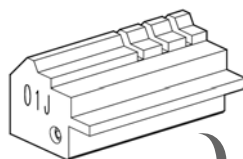

标准
STANDARD



D943254ZR
02J 夹钳
02J jaw

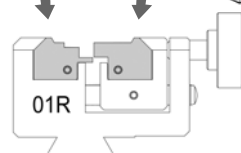
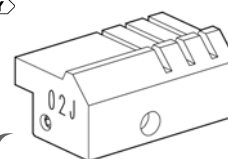

标准
STANDARD



D742867ZB
01D 刀具
Cutter 01D

PER:
FOR:

MERONI (I)

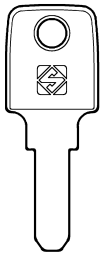

MER39
M4

可选
OPTIONAL
CODE
COPY

D743343ZB
14J 夹钳
14J Jaw

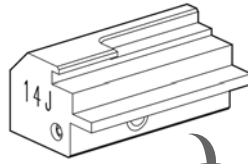

可选
OPTIONAL
CODE
COPY

D743361ZB
15J 夹钳
15J Jaw

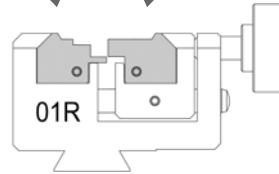
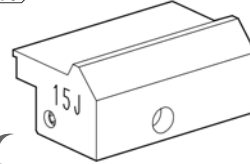

标准
STANDARD



D743671ZB
02L 刀具
Cutter 02L

为了
FOR:

SECUREMME (I)

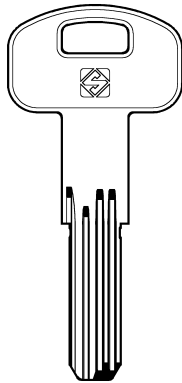

SCM2
K1

可选
OPTIONAL
CODE
COPY

D743341ZB
13J 夹钳
13J Jaw

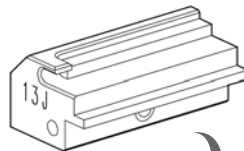

标准
STANDARD
CODE
COPY

D943254ZR
02J 夹钳
02J Jaw

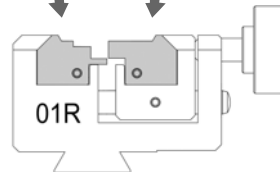
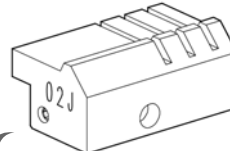

可选
OPTIONAL



D743673ZB
02D 刀具
Cutter 02D

为了
FOR:

SECUREMME (I)

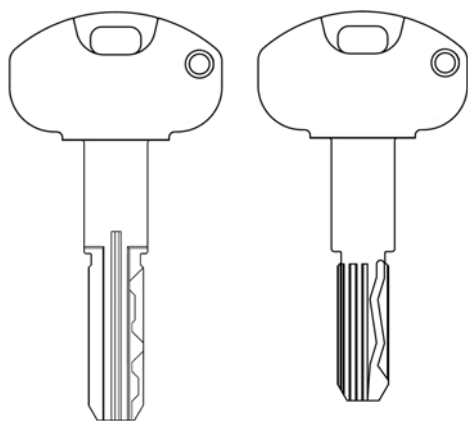

(K3)
5 pin



(K3)
5+5 pin

可选
OPTIONAL



D743261ZB
05J 夹钳
05J Jaw

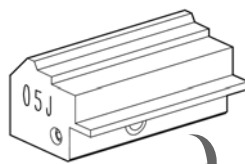

可选
OPTIONAL



D743262ZB
06J 夹钳
06J Jaw

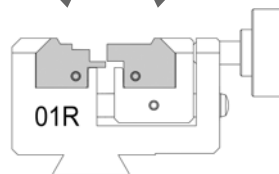
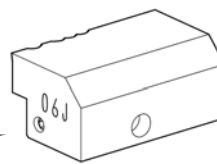

可选
OPTIONAL



D743673ZB
02D 刀具
Cutter 02D

为了
FOR:

SECUREMME (I)

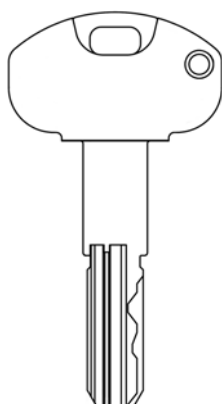

(K5)
6 pin

可选
OPTIONAL



D744017ZB
18J 夹钳
18J Jaw

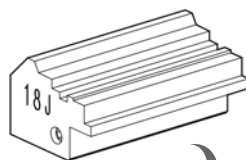

标准
STANDARD



D943254ZR
02J 夹钳
02J Jaw

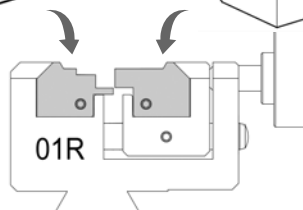
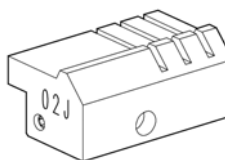

可选
OPTIONAL



D743673ZB
02D 刀具
Cutter 02D

Silca 公司根据授权提供密码保护的系统

System protected by a password issued by Silca on receipt of authorization.

为了
FOR:

STS (E)

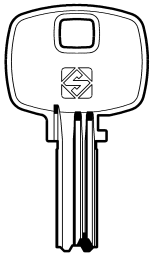

STS5

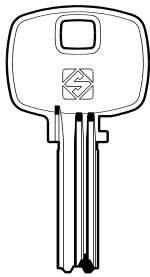

STS6

可选
OPTIONAL



D743340ZB

12J 夹钳
12J Jaw

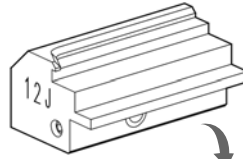

标准
STANDARD



D943254ZR

02J 夹钳
02J Jaw

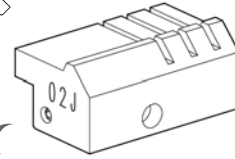

标准
STANDARD



D742867ZB

01D 刀具
Cutter 01D

为了
FOR:

AUDI (D)
FORD (D)
PORSCHE (D)
SEAT (E)
SKODA (CZ)
VOLKSWAGEN (D)



- | | | |
|---------|------------------|--------------------|
| HU66MH | HU66P | HU66AT5
HU66AT6 |
| HU66EHP | HU66T5
HU66T6 | |
| HU66FH | HU66T10 | HU66CT5
HU66DT5 |
| | HU66T15 | HU66CT6
HU66BT1 |
| HU75T | HU66T23 | HU66BT15
HU66TE |
| | HU66T26 | HU66BT28 |

HUF (D) - WITTE (D)

标准
STANDARD
CODE
COPY

D744023ZB
19J 夹钳
19J Jaw

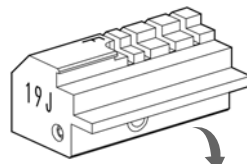

标准
STANDARD
CODE
COPY

D943254ZR
02J 夹钳
02J Jaw

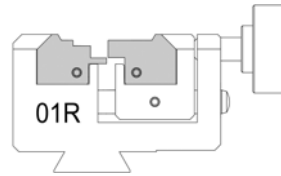
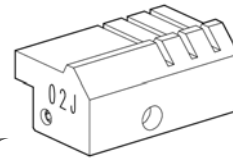

标准
STANDARD



D742606ZB
01L 刀具
Cutter 01L

为了
FOR:

BMW (D)

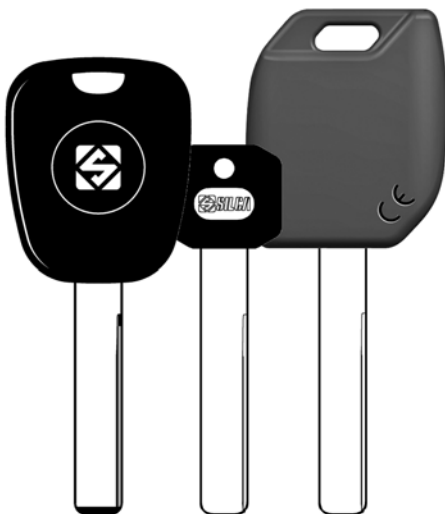

- | | | |
|--------|---------|---------|
| HU92RP | HU92RKP | HU92RMH |
|--------|---------|---------|

标准
STANDARD
CODE
COPY

D943253ZR
01J 夹钳
01J Jaw

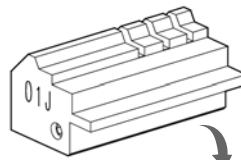

标准
STANDARD
CODE
COPY

D743256ZB
04J 夹钳
04J Jaw

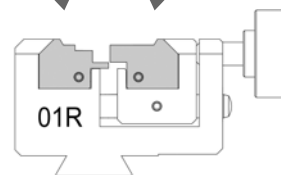
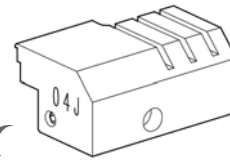

标准
STANDARD



D742606ZB
01L 刀具
Cutter 01L

为了
FOR:

CITROËN (F)



SX9CP SX9GP SX9T14 SX9MH

SX9AP SX9T6
SX10BP
SX11BP SX9TE
SX9EHP

VALEO - SIMPLEX (F)

可选
OPTIONAL

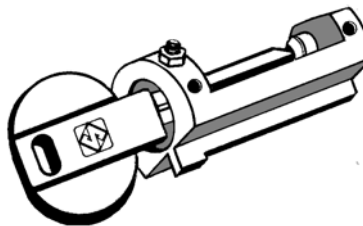

D708040ZB

为了SIMPLEX型钥匙而制作的B6适配器

Code adaptor B6 for SIMPLEX

为了
FOR:

FORD (EU+USA)

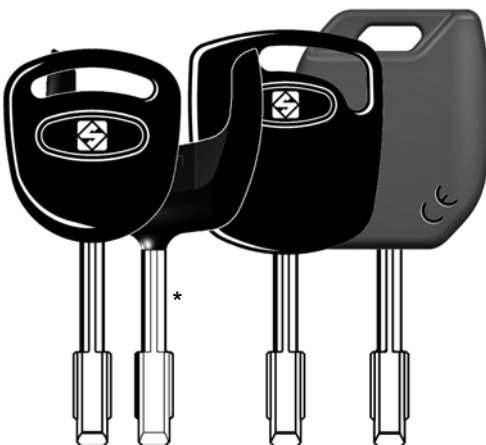

FO21P FO21AP FO21T3 FO21MH

FO21EH1 FO21T3M
FO21EH2 FO21T7
FO21TE
FO21FH

* **IMPORTANT!** Key blank to be applied to the original remote control (the remote control includes the transponder chip)

TIBBE (D)
VALEO (F)

标准
STANDARD

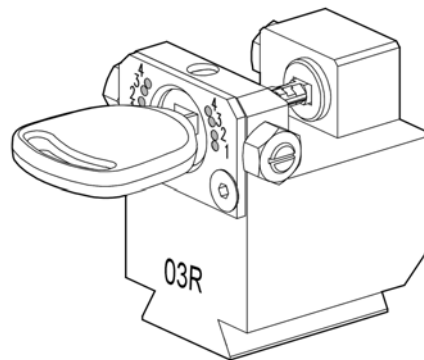

D743276ZB

03R 夹钳

03R Clamp

标准
STANDARD



D742606ZB

01L 刀具

Cutter 01L

为了
FOR:

FORD (D)

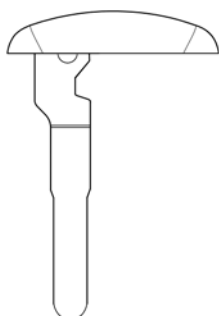

(Escape model)

标准
STANDARD
D744023ZB
19J 夹钳
19J Jaw

CODE

COPY

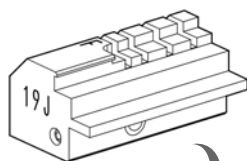

标准
STANDARD
D943254ZR
02J 夹钳
02J Jaw

CODE

COPY

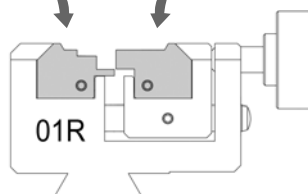
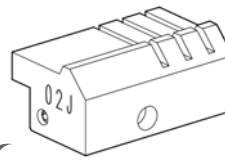

标准
STANDARD



D742606ZB
01L 刀具
Cutter 01L

为了
FOR:

HUF (D)

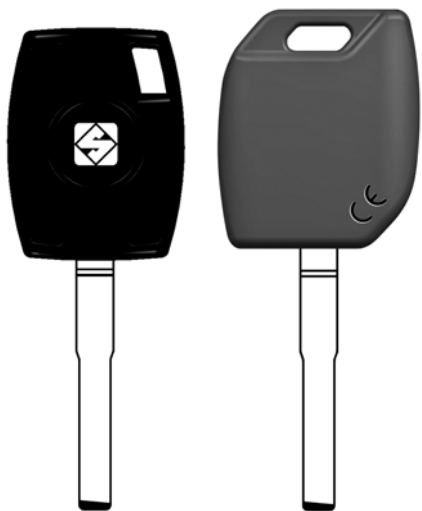

HU101T17
HU101T20
HU101TE

HU101MH

HU101T
HU101AP
HU101EH
HU101FH

标准
STANDARD
D744023ZB
19J 夹钳
19J Jaw

CODE

COPY

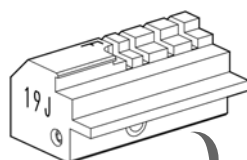

标准
STANDARD
D943254ZR
02J 夹钳
02J Jaw

CODE

COPY

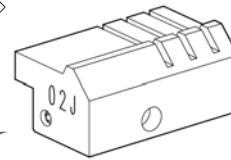

标准
STANDARD



D742606ZB
01L 刀具
Cutter 01L

为了
FOR:

MERCEDES (D)



HU41P

HU55P

HU64P

HU61AP

HU64T
HU65AP

HUF (D)

标准
STANDARD

D943253ZR

01J 夹钳

01J Jaw

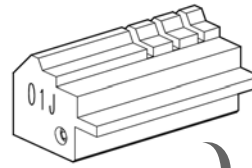

标准

STANDARD

D743256ZB

04J 夹钳

04J Jaw

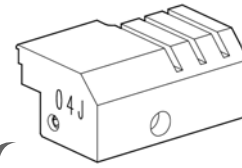

标准
STANDARD



D742606ZB

01L 刀具

Cutter 01L

为了
FOR:

管形钥匙

TUBULAR KEYS

AGA (E)
BILMA (E)

CHICAGO (USA)

L&F (GB)
KENSTAN (USA)

MERONI (I)

P.CORTELLEZZI (I)

SILCA (I)

BIL1T

CH9T
CH16T (9.2)
CH17T (10)

CH9T

MER22T (9.50)
MER25T (9.50)

PC12T (9.60)
PC12TP (9.60)
PC15T (9.60)
PC15TP (9.60)

SLC1TP (9.60)
SLC2TP (9.60)

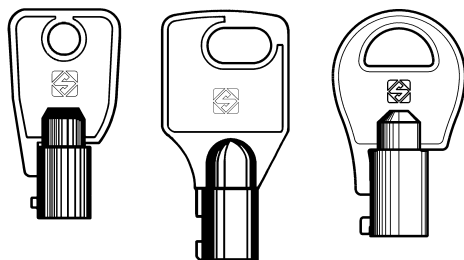

CH9T



MER22T



BIL1T

可选

OPTIONAL



D743275ZB

02R 夹钳

02R Clamp

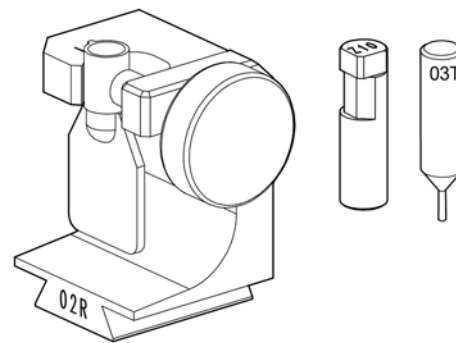

可选

OPTIONAL



D743672ZB

03L 刀具

Cutter 03L